



openWSPR Receiver User Manual

Getting Started

The openWSPR Receiver requires power, internet connection and a suitable antenna to function.

1. Connect a 5V power supply to the microUSB port labeled *OTG*. Since the receiver only consumes ~300mA@5V when running (500mA max), you might be able to power it from a USB port on your computer, although the use of an external DC 5V / ≥500mA power supply is recommended.
2. Connect a suitable antenna to the SMA connector. You may want to use different antennas for different frequencies, although a long vertical piece of wire is often sufficient for basic testing.
3. Connect an ethernet cable from your local network to the RJ45 jack. The receiver will be assigned a random IP address, based on your router's DHCP server settings.
4. Configure your receiver
 - a. Find out the local IP address of the receiver by logging into your router and looking for a device named *openwsprr-receiver*.

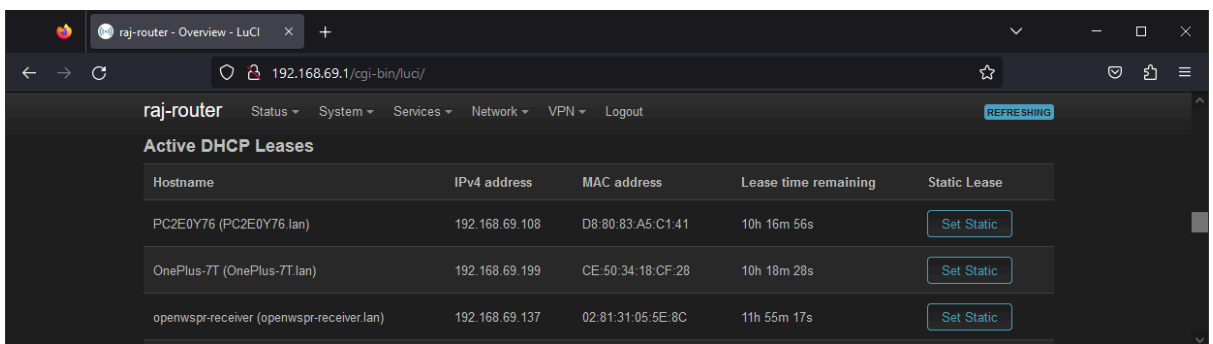

- b. Navigate to the receiver's IP address in your browser. Click the *Options* button, fill in your information and hit *Save*

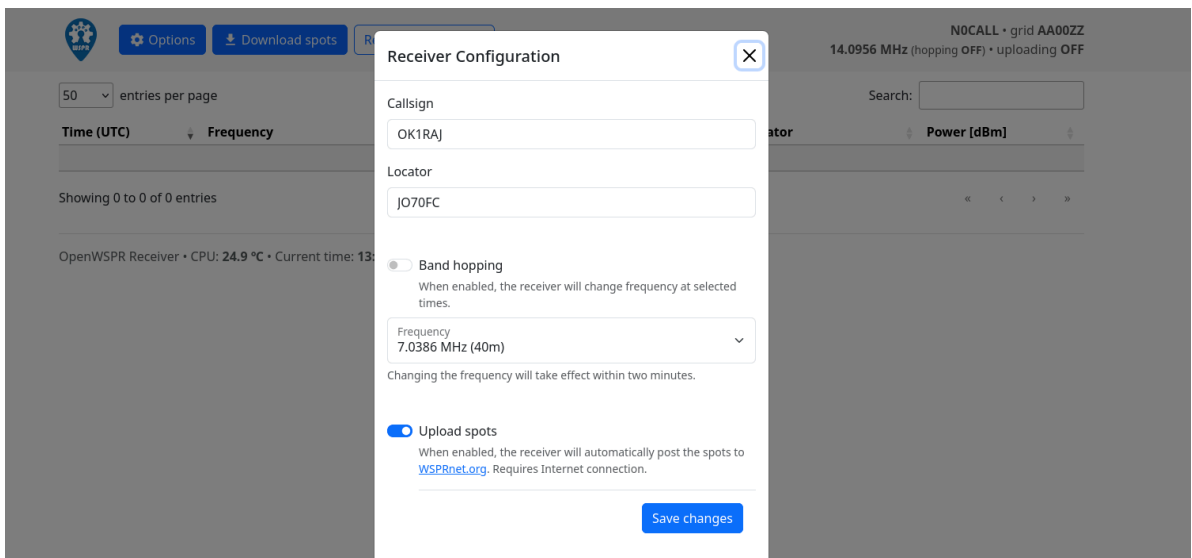

5. Well done! You can close the browser window and let your receiver work. Check back after a while to see if you managed to decode any signals. The receiver features two LEDs which can tell you what's going on without having to open your browser: see below for a detailed description.

Hint: If you're having trouble accessing your router's settings, try using a network scanner [like this](#) instead to identify your receiver's IP address.

I/O designation

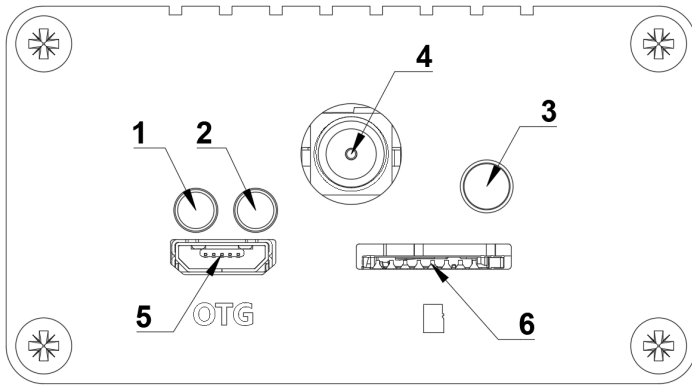

Front Panel

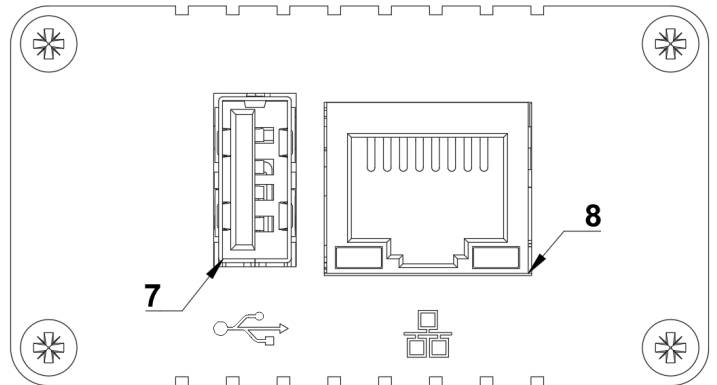

Back Panel

#	Name	Description / Function
1	System LED	Shines continuously if the system is running and has access to the Internet plus its clock is synchronized, which is required for full operation. In case of an error, it starts to blink until the system is connected and synchronized again
2	Decode LED	Indicates that latest WSPR spots are currently being decoded by blinking . After decoding is finished, the LED shines continuously if any spots have been decoded in the last 120s interval. Otherwise, the LED goes off until the next decoding time
3	User Button	Press and hold >2s to gracefully turn off the receiver
4	Antenna Connector	SMA antenna input, 50 Ohm impedance
5	microUSB Port	5V DC power input (500mA)
6	microSD Card Slot	(Included) microSD card with OS and decoding software
7	USB-A Port	Alternative configuration using a USB drive
8	Ethernet Connector	Internet connection

Dimensions [mm]

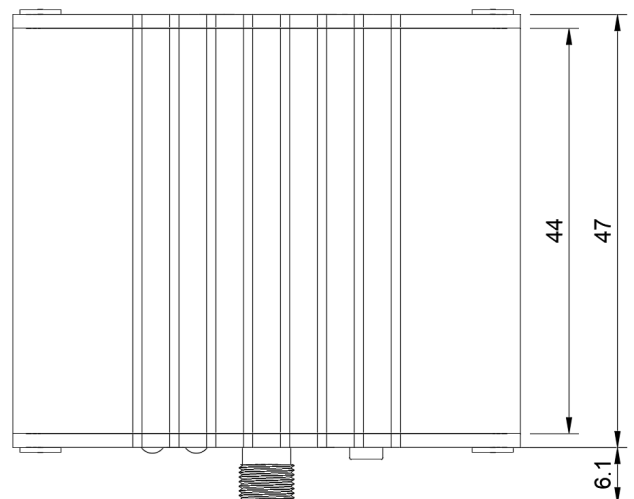
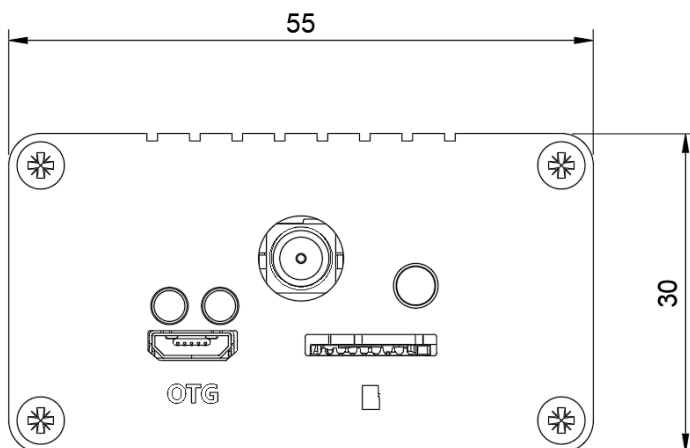



Alternative configuration methods

Instead of your browser, you can use a USB drive to configure your receiver. Just create a [config.txt](#) in the root of your flash drive and fill in the desired settings, like this:

```
#!/bin/bash
#
callsign="N0CALL"
grid="AA00ZZ"
frequency="7038600"
hopping="no"
upload_spots="no"
```

If you want to enable the band hopping feature, include a [hopping.txt](#) file as well. This file contains a schedule for changing frequencies, for example:

```
0100 3592600
0102 7038600
0200 10138700
```

Each line must be in format *HHMM freq*, where *HHMM* is UTC time and *freq* is frequency in Hz, which the receiver should start receiving at the given time.

Once you're done, plug the flash drive into the full size USB port on the receiver and restart it (unplug power, wait a little and plug it back in). During start-up, both LEDs will blink for several seconds to signal that the new setting has been successfully loaded. You can safely remove the drive afterwards.

If you know what you're doing, you can also connect to the receiver over SSH to gain complete control over your device. The SSH functionality needs to be specifically enabled in the config file described above. Just include a line *ssh="yes"* in the *config.txt* file. Login as *root* with the password *openwspr*. If you're planning to leave the ssh access enabled, we strongly recommend changing the password.

Updating the software

The receiver software lives inside armbian OS on the micro SD card. You can always download the latest microSD card image from [here](#). Take the following steps to load it into your receiver. **Note that your settings and decoded spots will be erased.** Download the spots / back up your settings if necessary!

1. Unplug your receiver and remove the SD card
2. Insert the SD card into your computer; dismiss any windows explorer pop-ups
3. Unzip the downloaded file
4. Download and install [balena Etcher](#), or similar, and start the program
5. Click on "Flash from file" and navigate to the unzipped .img file

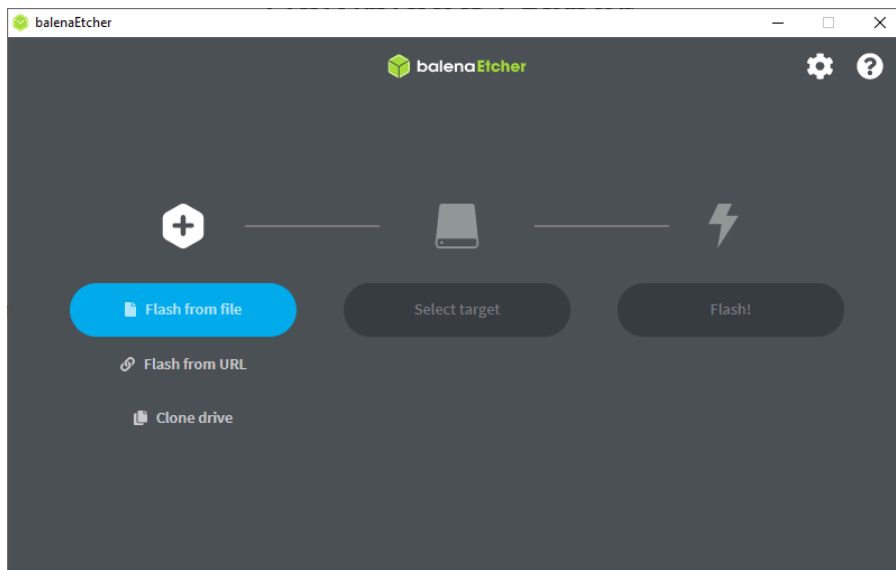

6. Click on "Select target" and select the SD card
7. Hit "Flash!" and wait
8. Once the program finishes flashing the file, you can disconnect the SD card; any windows explorer pop-ups may be safely ignored/dismissed
9. Put the SD card back into the receiver and plug the receiver back in